

Detailed operating instructions



**PD 360/8 Basic
EB10430411**



**PD 360i/8 Basic
EB10430435**



**PD 360/24 Basic
EB10430855**



**PD 360i/24 Basic
EB10430879**



**PD 360/8 Basic SMB
EB10430480**



**PD 360i/8 Basic SMB
EB10430473**



**PD 360/24 Basic SMB
EB10430893**



**PD 360i/24 Basic SMB
EB10430916**





Table of contents

1	Description	3
2	Safety instructions	3
3	Operation/functionality	4
3.1	Conditions in which the lighting is switched on	4
3.2	Conditions in which the lighting is switched off	4
3.3	Switching delay – not in pulse mode	4
4	Installation/connection	5
4.1	Masking the field of detection	7
5	Activation	7
5.1	Overview of factory settings	7
6	Settings	8
6.1	Control via external "S" button	8
6.2	Configuring parameters via remote control	8
6.3	Mobil-PDi/MDi	8
6.4	Mobil-PDi/MDi temporary settings	9
6.5	Programming the Mobil-PDi/MDi	9
6.6	Mobil-PDi/MDi-universal	11
6.7	Mobil-PDi/MDi-universal temporary settings	11
6.8	Programming the Mobil-PDi/MDi-universal	13
7	Technical data	15
8	Troubleshooting	15
8.1	Maintenance	16
8.2	Cleaning	16
9	ESYLUX manufacturer's guarantee	17



1 Description

The ESYLUX ceiling-mounted presence detector is a passive infrared presence detector that responds to moving heat sources, such as people walking.

The presence detector is designed for small rooms and passageways that benefit from natural light.

Note: Use this product only as intended (as described in the user instructions).

The device must not be changed, modified or painted — doing so will void any warranty claims. You must check the device for damage immediately after unpacking it. If there is any damage, you should not install the device under any circumstances.

If you suspect that safe operation of the device cannot be guaranteed, you should turn the device off immediately and make sure that it cannot be operated unintentionally.

2 Safety instructions

- **Work on the 230-V power system must be carried out by authorised personnel only, with due regard to the applicable installation regulations/standards**
- **Switch off the power supply before installing the system**
- **On the input side, the device is to be protected against short circuits with a 10-A circuit breaker**
- **Protection type IP 40 for interior use**



3 Operation/functionality

- 360° field of detection, 8 m / 24 m range at an installation height of 2.5 m
- Automatically controls light channels depending on presence and daylight
- With zero-cross switching

3.1 Conditions in which the lighting is switched on

The lighting is switched on if the target brightness value is below the preset lux value and movement is detected in the field of detection. Further movement is acknowledged by the sensor with two short flashes of the **red LED** (the LED can be switched off; see "Configuring parameters via remote control").

3.2 Conditions in which the lighting is switched off

The lighting is switched off if no movement is detected in the field of detection and the preset switch-off delay time has elapsed.

3.3 Switching delay — not in pulse mode

When persons are present, in order to avoid sudden changes in brightness caused by undesired switching on/off of the lighting, the detector will only be triggered after a time delay.

Example: a passing cloud could potentially cause unnecessary switching.

Time delay from light to dark: 30 sec. = **red LED** lights up during this period.

Time delay from dark to light: 5 min. = **red LED** flashes during this period.



4 Installation/connection

Note: Switch off the power supply before installing the system.

- The detectors can be flush mounted or surface mounted, and are also suitable for recessed ceiling mounting using accessories

Recessed mounting

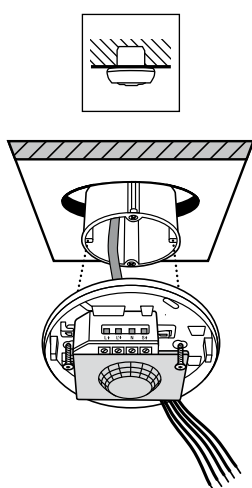

**Recessed ceiling mounting (see accessories)
for suspended ceilings**

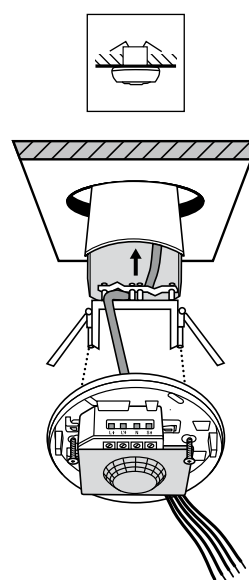

Surface mounting

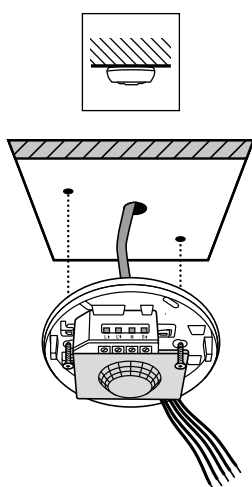

**Surface mounting
with spacers**

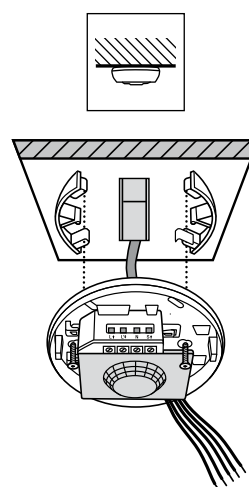



- Specifications regarding the range of the detector relate to an ambient temperature of approx. 20°C
- Movement crossways to the detector is optimal for triggering the detector; head-on approaches to the detector are more difficult to detect and therefore the range of the detector is significantly reduced

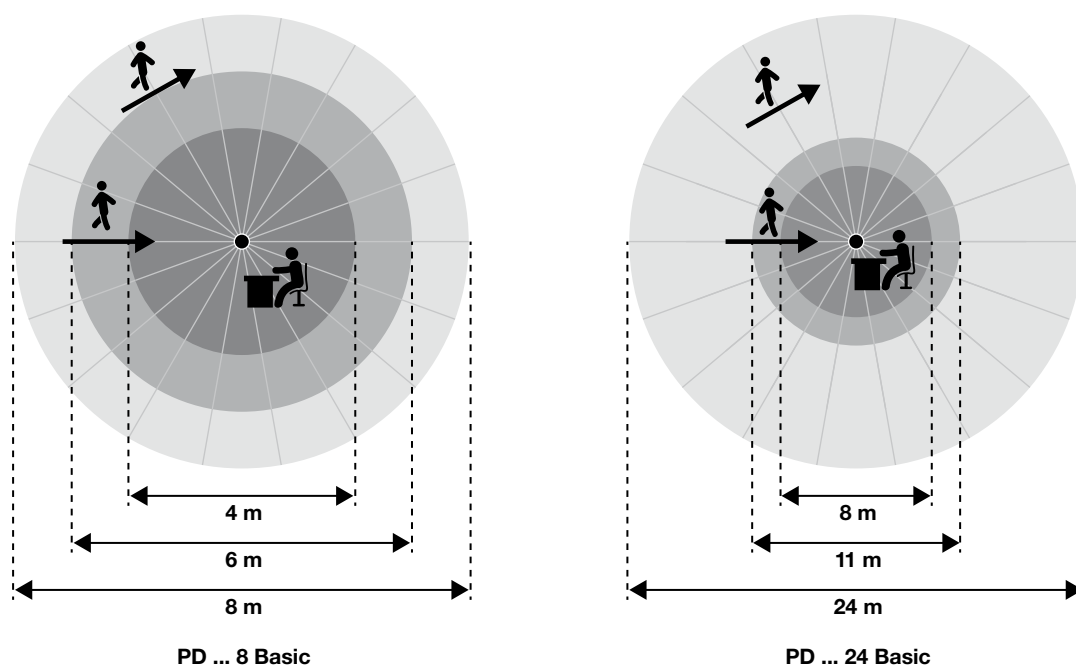

- The detector should be positioned depending on the available space and usage requirements
- Make sure that the detector has a clear line of sight, as infrared beams cannot penetrate solid objects
- Connect the detector in accordance with the circuit diagram

Single connection ————

Parallel connection - - - - -

L↑ Phase, 230 V
 L↓ Lighting
 N Neutral conductor
 S↑ Push button

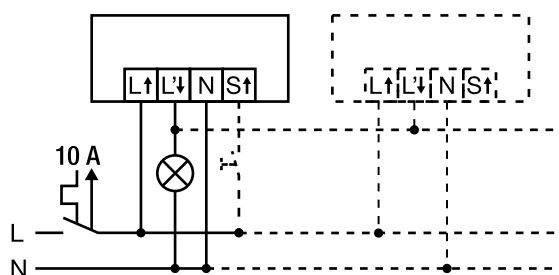



4.1 Masking the field of detection

Use the lens mask provided to mask out specific areas of detection.

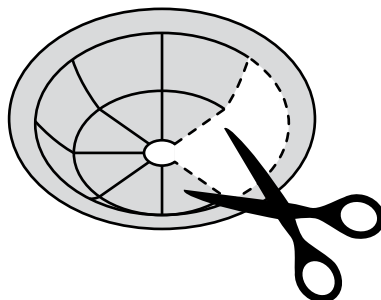

5 Activation

Connect the power supply.

A warm-up phase of 25 seconds is initiated. The **red LED** flashes. During this time, the lighting is switched on.

5.1 Overview of factory settings

Factory settings

Light value	approx. 500 lux
Switch-off delay time	5 min.
Sensitivity	100 %

The manual setting element values are active on delivery. The values can be overridden at any time by programming the detector using one of the optional remote controls.



6 Settings

6.1 Control via external "S" button

The ceiling-mounted presence detector is equipped with a connection for an external button (S terminal). This can be used to switch the lighting on and off manually.

Modes activated by pressing the external button:

- Press button for approx. 1 second:** The lighting is switched on or off (for the duration of the switch-off delay time)
- Press button for approx. 3 second:** The lighting is switched on or off continuously for 4 hours

Further parameters can be configured via remote control. Remote controls can be purchased as accessories.

6.2 Configuring parameters via remote control

Only models:

PD 360i/8 Basic	EB10430435	PD 360i/24 Basic	EB10430879
PD 360i/8 Basic SMB	EB10430473	PD 360i/24 Basic SMB	EB10430916

Note: For optimum reception, when programming the settings, point the remote control at the detector. Please note that if the sensor is exposed to direct sunlight, the standard detection range of approx. 8 m may be dramatically reduced due to the sun's infrared rays.



6.3 Mobil-PDi/MDi (EM10425509)







6.4 Mobil-PDi/MDi temporary settings

Parameter configurations are only temporarily applied.





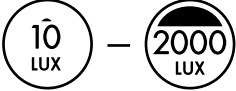

Function	Customised setting
	<p>ON/OFF Switching the lighting ON/OFF manually. Note: The "ON/OFF" mode can be cancelled by pressing the "Reset" button. "ON" acknowledgement: Movement detected in the field of detection is acknowledged with two short flashes of the red LED. "OFF" acknowledgement: Movement detected in the field of detection is acknowledged with one short flash of the red LED.</p>
	<p>Reset/settings Temporarily set values are cleared and the detector returns to the manually preset operating mode.</p>
	<p>4 h ON/OFF The lighting is switched on or off continuously for approx. 4 hours. If no movement is detected in the field of detection and the preset switch-off delay time has elapsed, the detector returns to the previous operating mode. Note: The "4 h ON/OFF" mode can be cancelled by pressing the "Reset" button.</p>

6.5 Programming the Mobil-PDi/MDi



Alterations to parameters are applied permanently.

Function	Customised setting
	<p>Enter programming mode The detector goes into programming mode. Acknowledgement: The red LED lights up permanently and the lighting is switched on continuously.</p>
	<p>Exit programming mode The set parameters are stored on the detector. Acknowledgement: The red LED is switched off.</p>
	<p>Set the brightness switching value, max. 2000 lux The detector switches the lighting on if the target brightness value is below the preset lux value and movement is detected in the field of detection. Acknowledgement: The red LED flashes three times.</p>



Function	Customised setting
	<p>The detector operates in daytime mode Light measurement is no longer active.</p>
	<p>Take a reading of the current ambient light value The detector switches the lighting on if the target brightness value is below the preset lux value and movement is detected. Acknowledgement: The red LED and the lighting are switched off for approx. 5 seconds while the reading is taken.</p>
	<p>Fully automatic/semi-automatic mode The lighting can be controlled in fully automatic and semi-automatic modes. Fully automatic: The lighting is switched on depending on the set lux value and movement being detected. If movement is no longer detected, the preset switch-off delay time will start. The relevant active status can be optionally overridden using the external "S" button. Acknowledgement: The red LED flashes three times. Semi-automatic: Control (activation of the lighting) via the external "S" button. The lighting remains switched on as long as movement is detected and the target brightness value is greater than the preset lux value. Acknowledgement: The red LED is switched off for approx. 2 seconds.</p>
	<p>Short pulse As soon as movement has been detected in the field of detection, the detector switches the lighting on for approx. 5 second and off for approx. 5 seconds. This function can be used to control automatic stairwell lights, for example. Acknowledgement: The red LED is switched on for approx. 5 seconds and off for 5 seconds.</p>
	<p>Switch-off delay time The switch-off delay time starts once movement is no longer detected in the field of detection. Acknowledgement: The red LED flashes.</p>
	<p>PIR sensitivity Settings: maximum (100 %), 75 %, 50 %, minimum (25 %) The sensitivity of the detector for the purpose of detecting movement can be set. Acknowledgement: The red LED flashes three times.</p>



Function	Customised setting
	<p>Detector LEDs ON/OFF The LEDs in the detector can be switched on or off.</p> <p>Acknowledgement: LEDs OFF: The red LED is switched off for approx. 2 seconds. LEDs ON: The red LED flashes three times.</p>
	<p>Reset The remote control settings are reset and the detector uses the manual potentiometer values.</p> <p>Acknowledgement: The red LED flashes three times.</p>

6.6 Mobil-PDi/MDi-universal (EP10433993)

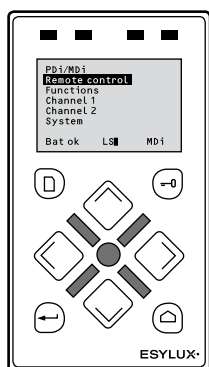

6.7 Mobil-PDi/MDi-universal temporary settings

Parameter configurations are only temporarily applied.

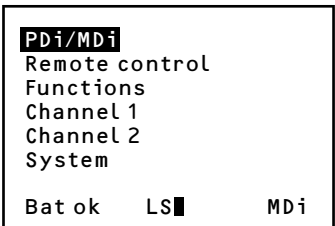
Function	Customised setting
	<p>Selecting remote control:</p>



Function	Customised setting
<div style="border: 1px solid black; padding: 5px;"> PDi/MDi Remote control Functions Channel 1 Channel 2 System Bat ok LS ■ MDi </div>	To configure temporary settings, select the sub-item " Functions " in the " PDi/MDi " menu.
<div style="border: 1px solid black; padding: 5px;"> Functions ON/OFF Test Reset 4 h ON/OFF Bat ok LS ■ MDi </div>	<p>ON/OFF Manual switching on/off of lighting. Note: The "4h ON/OFF" mode cannot be interrupted using the "ON/OFF" function; it can only be interrupted using the "Reset" function. "ON" acknowledgement: Movement detected in the field of detection is acknowledged with one short flash of the red LED. "OFF" acknowledgement: Movement detected in the field of detection is not acknowledged.</p>
<div style="border: 1px solid black; padding: 5px;"> Functions ON/OFF Test Reset 4 h ON/OFF Bat ok LS ■ MDi </div>	<p>Reset/settings Temporarily set values are cleared. The detector returns to the preset operating mode.</p>
<div style="border: 1px solid black; padding: 5px;"> Functions ON/OFF Test Reset 4 h ON/OFF Bat ok LS ■ MDi </div>	<p>4h ON/OFF The lighting is switched on or off continuously for approx. 4 hours. If no movement is detected in the field of detection and the preset switch-off delay time has elapsed, the detector returns to the previous operating mode. Note: The "4h ON/OFF" mode can be temporarily exited using the "Reset" function. Acknowledgement: slow flashing.</p>





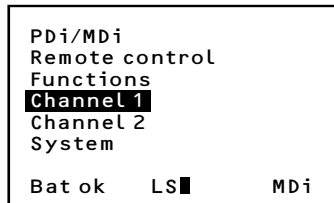

6.8 Programming the Mobil-PDi/MDi-universal

Programmed values are applied permanently.



1. Select the sub-item "**Channel 1**" in the "**PDi/MDi**" menu.

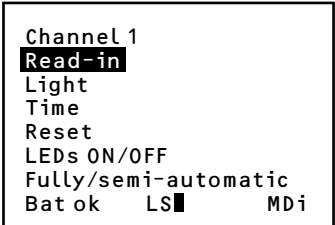
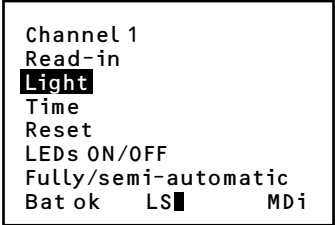

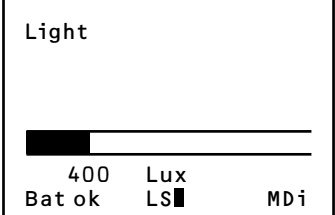
2. Then press the  button to enter programming mode. **Acknowledgement:** The red LED lights up permanently and the lighting is switched on continuously.
3. Press the  button to exit programming mode. **Acknowledgement:** The red LED is switched off.

Function	Customised setting
 <pre> Channel 1 Read-in Light Time Reset LEDs ON/OFF Fully/semi-automatic Bat ok LS■ MDi </pre>	<p>Take a reading of the current ambient light value</p> <p>The detector switches the lighting on if the target brightness value is below the preset lux value and movement is detected in the field of detection.</p> <p>Acknowledgement: The red LED and the lighting are switched off for approx. 5 seconds while the reading is taken.</p>
 <pre> Channel 1 Read-in Light Time Reset LEDs ON/OFF Fully/semi-automatic Bat ok LS■ MDi </pre>	<p>Set the brightness switching value</p> <p>Setting values: 10, 100, 250, 400, 600, 800, 2000 lux</p> <p>The detector switches the lighting on if the target brightness value is below the preset lux value and movement is detected in the field of detection.</p> <p>Acknowledgement: The red LED flashes three times in cycles if the selected brightness switching value has been confirmed using the  button.</p>
 <pre> Light ████████████████████████████████████████ 400 Lux Bat ok LS■ MDi </pre>	

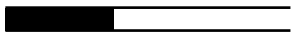

Function	Customised setting
<div style="border: 1px solid black; padding: 5px;"> Channel 1 Read-in Light Time Reset LEDs ON/OFF Fully/semi-automatic Bat ok LS ■ MDi </div>	<p>Switch-off delay time</p> <p>Setting values: Short pulse, 1, 2, 5, 10, 15 min.</p> <p>Short pulse As soon as movement has been detected in the field of detection, the detector switches the lighting on for approx. 5 second and off for approx. 5 seconds. This function can be used for operating automatic stairwell lights, for example.</p> <p>Acknowledgement: The red LED is switched on for 5 seconds and off for 5 seconds.</p> <p>Switch-off delay time: 1, 2, 5, 10, 15 min. The switch-off delay time starts once movement is no longer detected in the field of detection.</p> <p>Acknowledgement: The red LED flashes three times in cycles.</p>
<div style="border: 1px solid black; padding: 5px;"> Time  5 min Bat ok LS ■ MDi </div>	
<div style="border: 1px solid black; padding: 5px;"> Channel 1 Read-in Light Time Reset LEDs ON/OFF Fully/semi-automatic Bat ok LS ■ MDi </div>	<p>Reset/factory settings The remote control settings are reset and the detector uses the manual potentiometer values.</p> <p>Acknowledgement: The red LED flashes three times.</p>
<div style="border: 1px solid black; padding: 5px;"> Channel 1 Read-in Light Time Reset LEDs ON/OFF Fully/semi-automatic Bat ok LS ■ MDi </div>	<p>Detector LEDs ON/OFF The LEDs in the detector can be switched on or off by pressing the  button.</p> <p>Acknowledgement: LEDs OFF: The red LED is switched off for approx. 2 seconds. LEDs ON: The red LED flashes three times.</p>
<div style="border: 1px solid black; padding: 5px;"> Channel 1 Read-in Light Time Reset LEDs ON/OFF Fully/semi-automatic Bat ok LS ■ MDi </div>	<p>Fully automatic/semi-automatic mode The lighting can be controlled in fully automatic and semi-automatic modes by pressing the  button.</p> <p>Fully automatic: The lighting is switched on depending on the set lux value and movement being detected. If movement is no longer detected, the preset switch-off delay time will start. This mode can be optionally switched on or off using the external "S" button.</p> <p>Acknowledgement: The red LED flashes three times.</p> <p>Semi-automatic: The lighting is controlled using the external "S" button. The lighting remains switched on as long as movement is detected and the target brightness value is greater than the preset lux value.</p> <p>Acknowledgement: The red LED is switched off for approx. 2 seconds.</p>



7 Technical data

Operating voltage	230 V AC
μ = contact opening width	≤ 1.2 mm
Target brightness value approx.	5 - 2000 lux
Switching capacity	2300 W / 10 A (cos phi = 1) 1150 VA / 5A (cos phi = 0.5)
Max. inrush current	800 A / 200 μ s
Switch-off delay time	Short pulse / approx. 15 sec. - 30 min.
Protection type / protection class	IP 40 / II
Operating temperature range	0°C to +50°C

8 Troubleshooting

Fault	Cause
Lighting does not switch on.	<ul style="list-style-type: none"> - Ambient light level is above the preset target brightness value - Lighting has been switched off manually - There are people in the field of detection - There are sources of thermal interference in the field of detection, such as heating, air-conditioning or moving objects (e.g. curtains by open windows) - The switch-off delay time has been set too short
Lighting is switched off during the hours of darkness despite the presence of persons	<ul style="list-style-type: none"> - Ambient light level is above the preset target brightness value - Lighting has been switched off manually
Lighting does not switch off or lighting switches on spontaneously when no persons are present.	<ul style="list-style-type: none"> - The switch-off delay time has not yet elapsed - There are sources of thermal interference in the field of detection, such as heating, air-conditioning or moving objects (e.g. curtains by open windows)
Button does not work.	<ul style="list-style-type: none"> - Device is still in the start-up phase - Illuminated button has been used without a neutral wire connection - Button is not routed to the "S terminal"
Lighting switches on and off in warm-up phase.	<ul style="list-style-type: none"> - Detector exposed to too much artificial light
Detector does not respond.	<ul style="list-style-type: none"> - Check the power supply



8.1 Maintenance

The ceiling-mounted presence detector does not contain any components that require maintenance. The device can only be replaced as a complete unit.



Note: This device must not be disposed of as unsorted household waste. Used devices must be disposed of correctly. Contact your local town council for more information.

8.2 Cleaning

No corrosive cleaning agents or solvents may be used for cleaning and care of the device. Please use a lint-free cloth that is either dry or dampened only with water.



9 ESYLUX manufacturer's guarantee

ESYLUX products are tested in accordance with applicable regulations and manufactured with the utmost care. The guarantor, ESYLUX Deutschland GmbH, Postfach 1840, D-22908 Ahrensburg, Germany (for Germany) or the relevant ESYLUX distributor in your country (visit www.esylux.com for a complete overview) provides a guarantee against manufacturing/material defects in ESYLUX devices for a period of three years from the date of manufacture.

This guarantee is independent of your legal rights with respect to the seller of the device. The guarantee does not apply to natural wear and tear, changes/interference caused by environmental factors or damage in transit, nor to damage caused as a result of failure to follow the user or maintenance instructions and/or as a result of improper installation. Any illuminants or batteries supplied with the device are not covered by the guarantee. The guarantee can only be honoured if the device is sent back with the invoice/receipt, unchanged, packed and with sufficient postage to the guarantor, along with a brief description of the fault, as soon as a defect has been identified.

If the guarantee claim proves justified, the guarantor will, within a reasonable period, either repair the device or replace it. The guarantee does not cover further claims; in particular, the guarantor will not be liable for damages resulting from the device's defectiveness. If the claim is unfounded (e.g. because the guarantee has expired or the fault is not covered by the guarantee), then the guarantor may attempt to repair the device for you for a fee, keeping costs to a minimum.